

CUT SMALL DOTTED LINE

It's never too early to introduce kids to God's Word! Use the 26 flash cards to help make learning Scripture as easy as ABC for your child. Simply cut along the dotted lines and fold along the solid center line to create these fun flash cards. Use markers or crayons to add color to your robots.

FOLD CENTER LINE

A simple way for toddlers to memorize Scripture

ABC Bible Verses

CUT SMALL DOTTED LINE

PSALM 46:10

"Be still, and know that I am God."

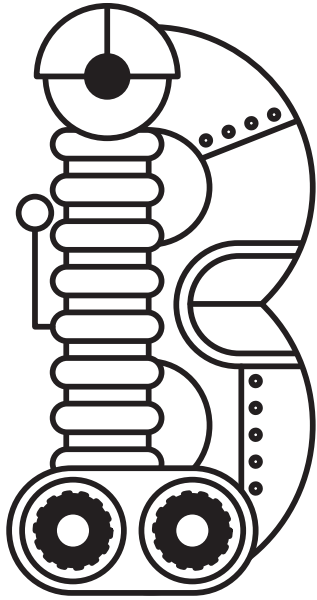

B

MATTHEW 7:7

"Ask, and it will be given to you; seek, and you will find."

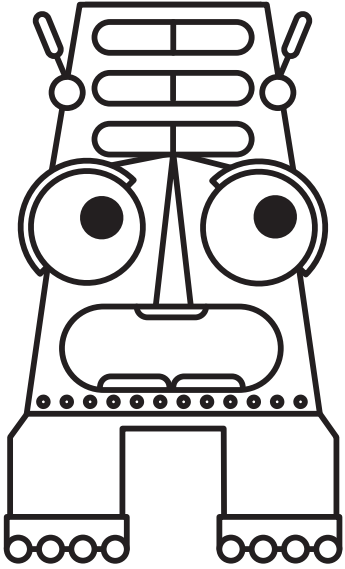

A

COLOSSIANS 3:20

“Children,
obey your parents
in everything.”

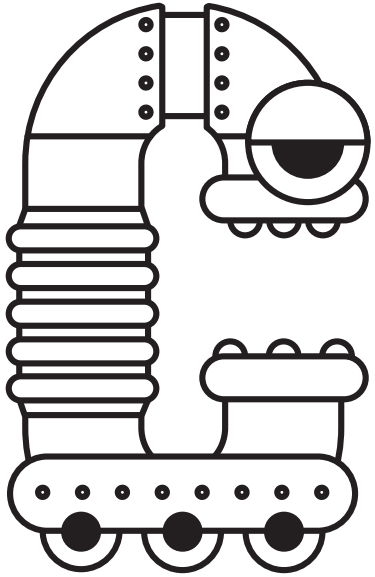

C

PHILIPPIANS 4:6

“Do not be anxious
about anything.”

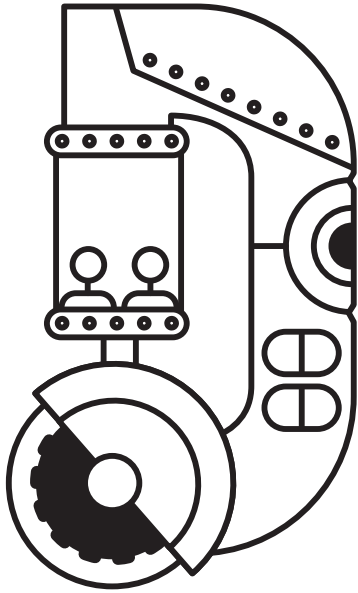

D

PROVERBS 30:5

“Every
word of God
proves true.”

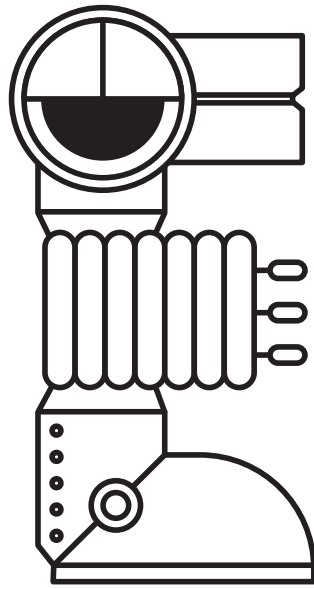

E

EPHESIANS 2:8

“For by grace you
have been saved
through faith.”

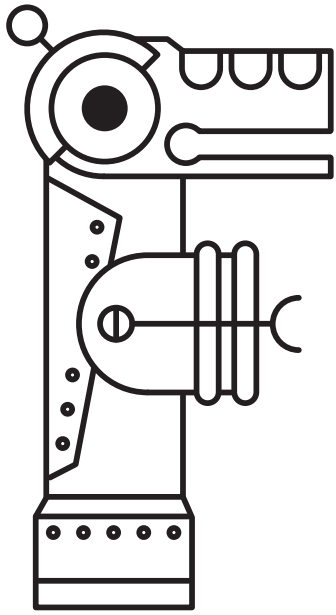

F

MATTHEW 28:19

“Go therefore
and make disciples
of all nations.”

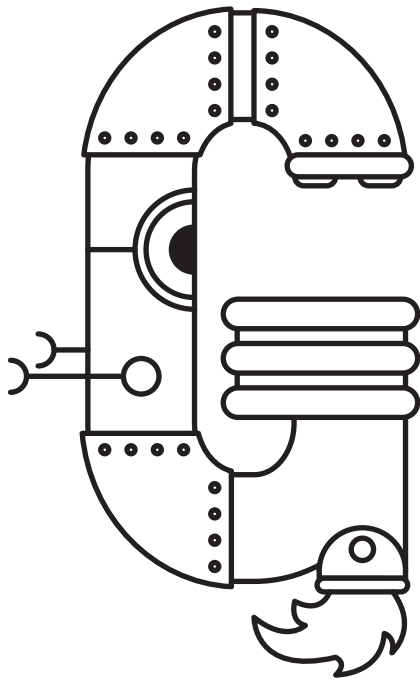

G

JAMES 4:10

“Humble
yourselves before
the Lord.”

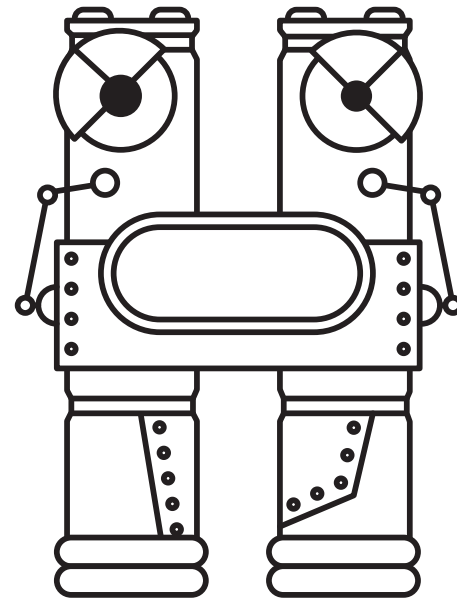

H

JOHN 10:11

"I am the good shepherd. The good shepherd lays down his life for the sheep."

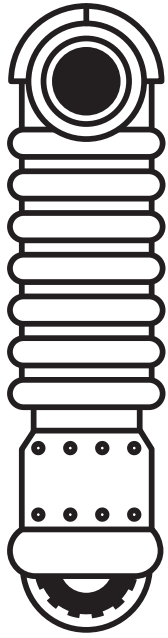

I

HEBREWS 13:8

"Jesus Christ is the same yesterday and today and forever."

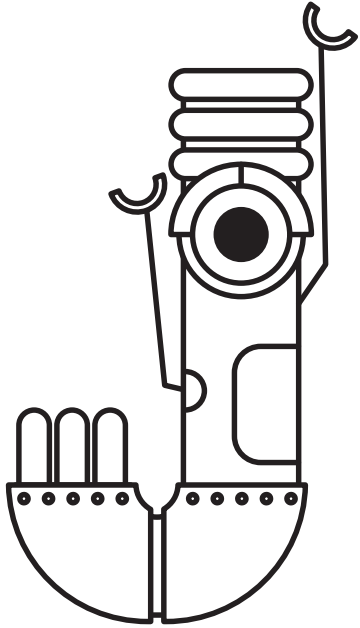

J

PSALM 100:3

"Know that the Lord, he is God!"

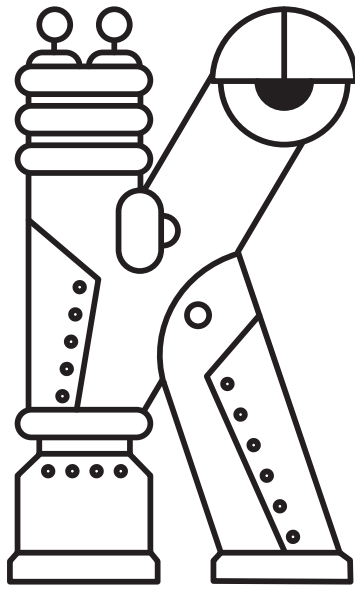

K

1 CORINTHIANS 13:4

“Love
is patient
and kind.”

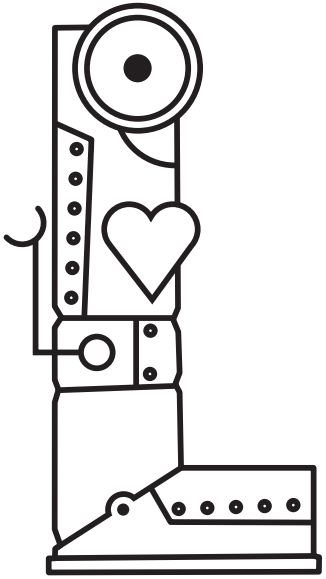

L

PSALM 98:4

“Make a joyful
noise to the Lord,
all the earth.”

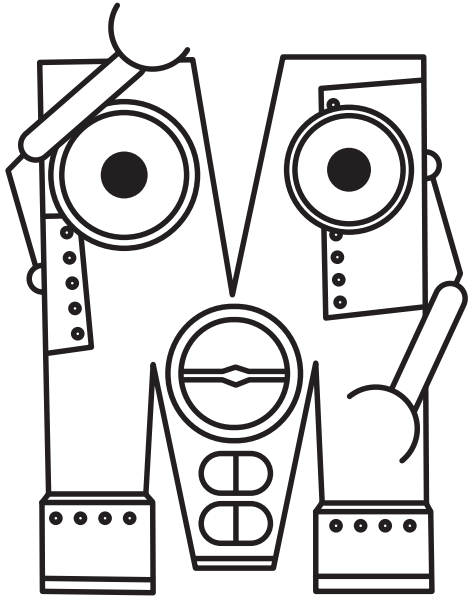

M N

LUKE 1:37

“Nothing
will be impossible
with God.”

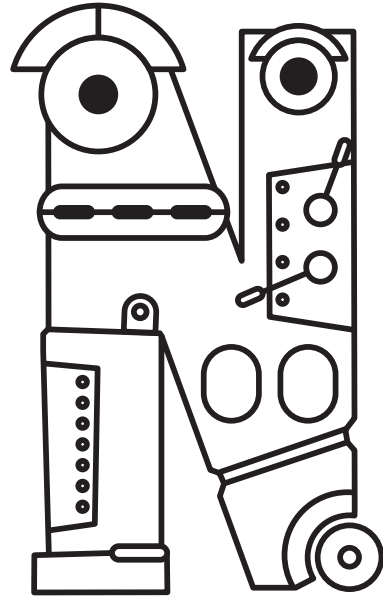

MATTHEW 6:9

“Our Father in heaven, hallowed be your name.”

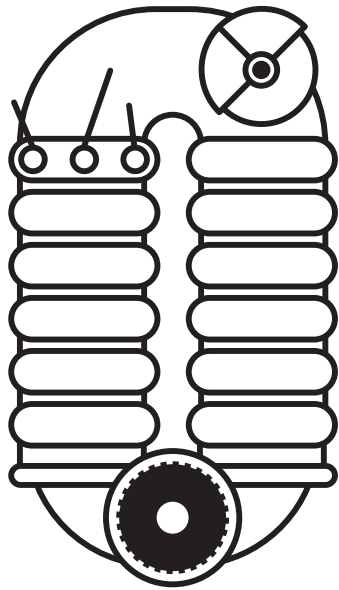

O

PSALM 146:1

“Praise the Lord, O my soul!”

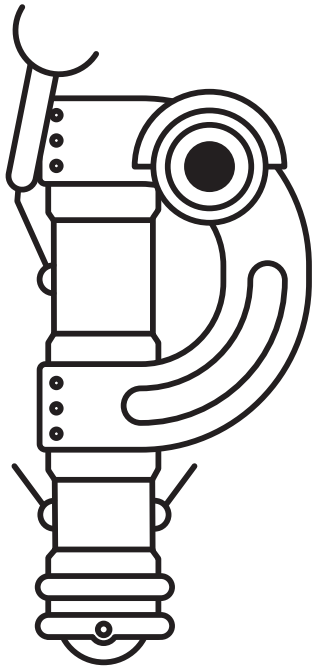

P

1 THESSALONIANS 5:19

“Do not quench the Spirit.”

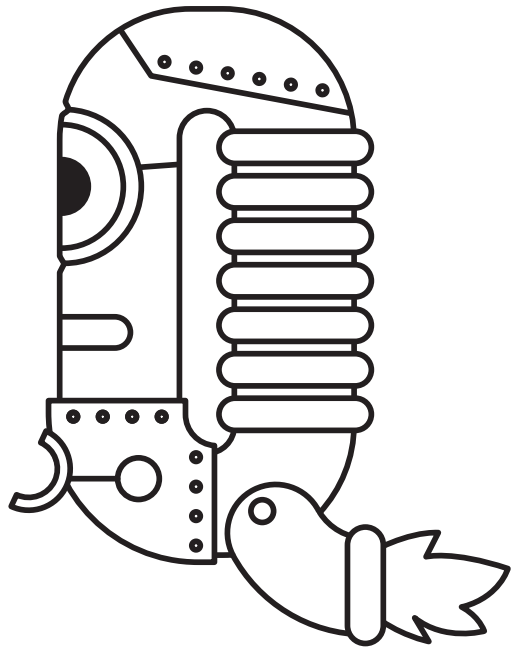

Q

PHILIPPIANS 4:4

“**Rejoice** in the Lord always; again I will say, rejoice.”

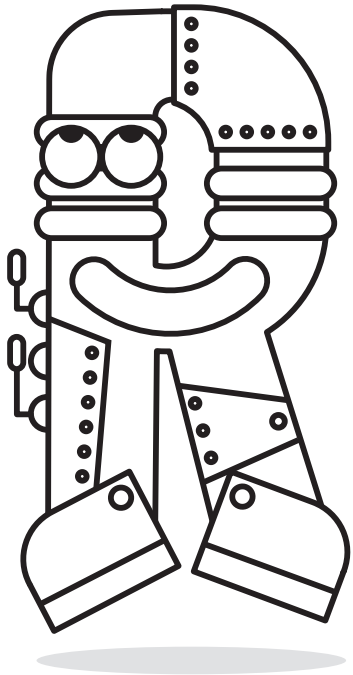

R

PSALM 30:4

“**Sing** praises to the Lord, O you his saints.”

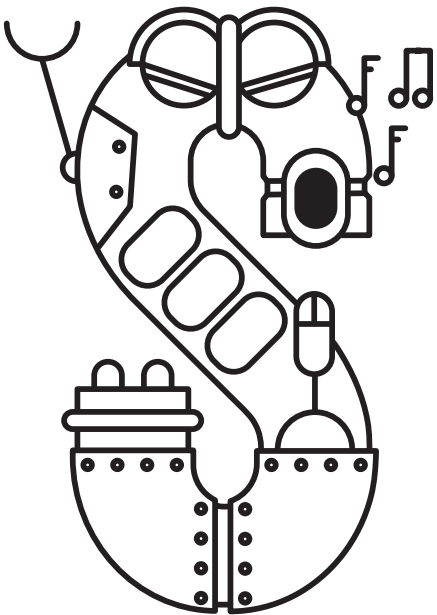

S

PROVERBS 3:5

“**Trust** in the Lord with all your heart.”

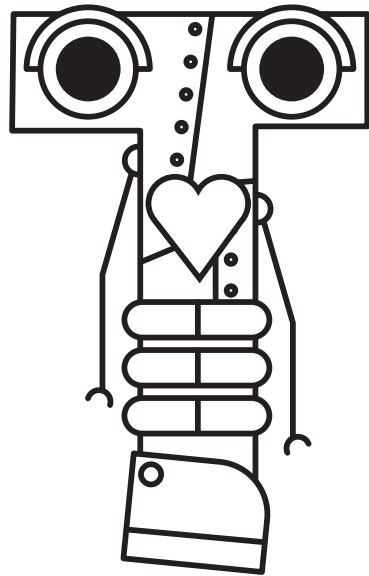

T

LUKE 2:11

“Unto you is born
this day in the city of
David a Savior.”

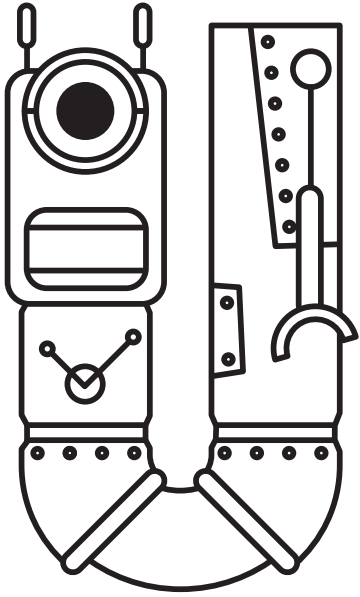

U

PROVERBS 21:31

“Victory
belongs to
the Lord.”

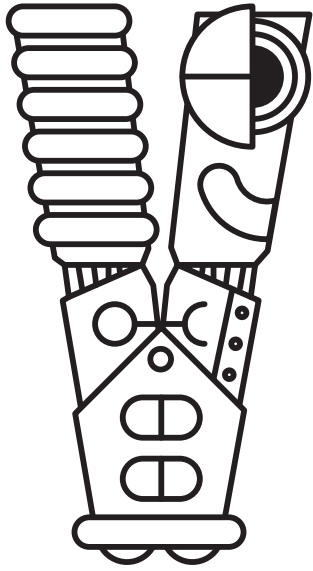

V

1 JOHN 4:19

“We love because
he first loved us.”

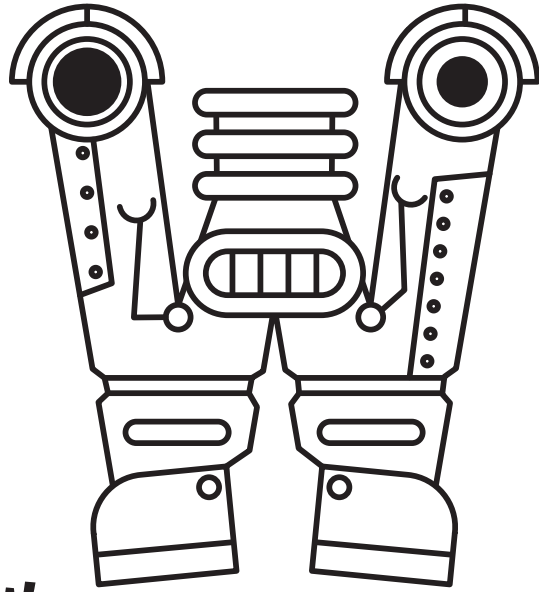

W

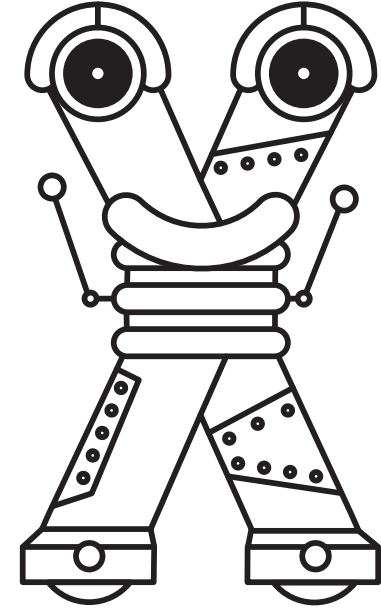

X

“Exalted
be my God,
the rock of my
salvation.”

2 SAMUEL 22:47

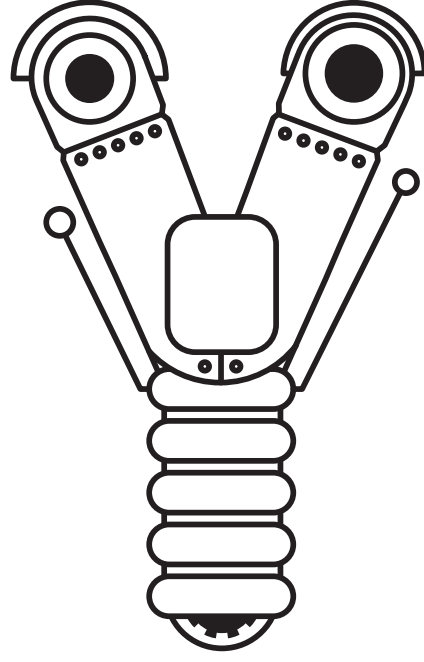

Y

“You
are the light
of the world.”

MATTHEW 5:14

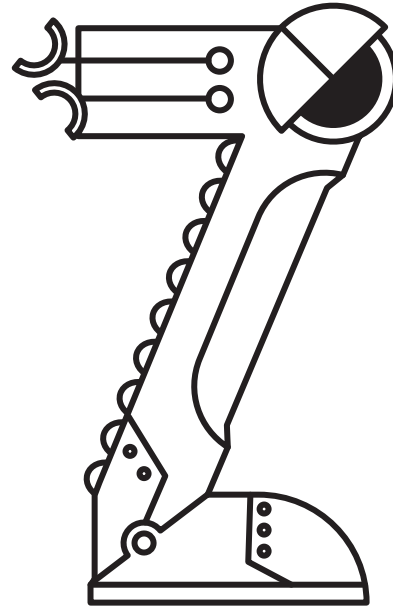

Z

“Now who is there
to harm you if you
are **zealous**
for what is good?”

1 PETER 3:13